

42 W Dimmable Freedom LED driver

Product code: 5810

42 W 220 – 240 V 0 / 50 – 60 Hz

- Future-proof Freedom Interface to power Freedom Node, enabling a various wireless lighting control systems support
- Enhanced Hybrid Dimming technology for high quality light output.
- 1 - 100 % dimming range
- Very high efficiency up to 93 %
- Low current ripple
- Suitable for DC use
- Long lifetime up to 100 000 h
- Driver protection Class I
- Ideal solution for Class I luminaires, suitable for Class II luminaires too*



Freedom

* See page 5 for details.

Functional Description

- Adjustable constant current output: 120 mA (default) to 350 mA
- Current setting with external resistors
- Full load recognition with automatic recovery and adaptive LED overload / open circuit / short circuit protection
- Inbuilt power supply for external Freedom Node / luminaire intelligent unit use
- Extensive smart data availability through Freedom Interface, including e.g power consumption monitoring.
- Helvar Freedom Interface 1.5 support

Mains Characteristics

Nominal rated voltage range	220 V – 240 V, 0 / 50 – 60 Hz
AC voltage range	198 VAC – 264 VAC
	Withstands max. 320 VAC (max. 1 hour)
	Withstands min. 176 VAC (max. 1 hour)
DC voltage range	176 VDC – 280 VDC
DC starting voltage	> 190 VDC
Mains current at full load	0.18 – 0.24 A
Frequency	0 / 50 Hz – 60 Hz
Stand-by power consumption	< 0.5 W
THD at full power	< 10 %
Leakage current to earth	< 0.4 mA
Tested surge protection	1 kV L-N, 2 kV L-GND (IEC 61000-4-5)
Tested fast transient protection	4 kV (IEC 61000-4-4)

Insulation between circuits & driver case

Mains circuit - Output	Non-isolated
Mains circuit - Freedom Node interface	Non-isolated
Mains, Interface and output - Driver case	Basic insulation

Load Output (non-isolated)

Output current (I_{out})	120 mA (default) – 350 mA
Accuracy	± 5 %
Ripple	< 2 %* at ≤ 120 Hz
	*] Low frequency, LED load: Cree MX3 LEDs
U_{out} (max) (abnormal)	400 V

I_{LED}	120 mA	350 mA
P_{Rated}	42 W	42 W
U_{LED}	80 – 350 V	50 – 120 V
PF (λ) at full load	0.96	0.96
Efficiency (η) at full load	93 %	91 %

Operating window

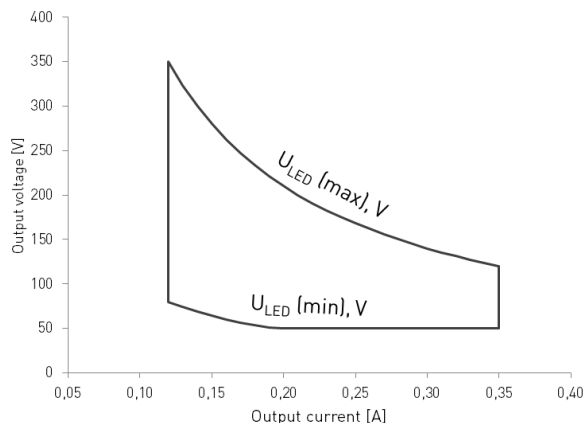

Note: Dimming between 1% - 100% possible across the whole operating window

Driver performance

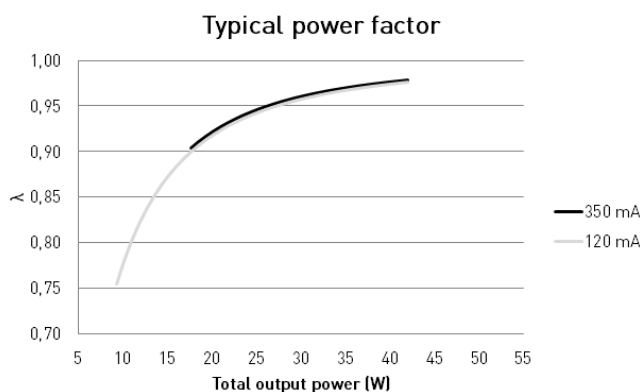
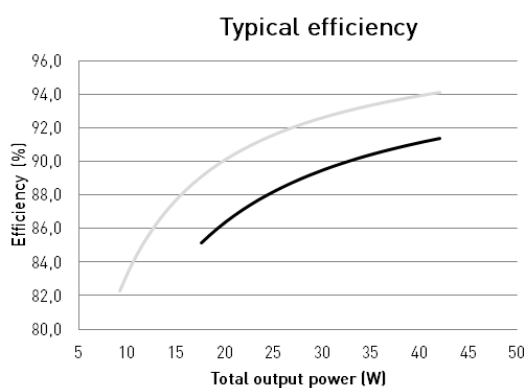

Operating Conditions and Characteristics

Absolute highest allowed t_c point temperature	75 °C
T_c life (60 000 h) temperature	75 °C
Ambient temperature range	-25 °C .. +50 °C*
Storage temperature range	-40 °C .. +80 °C
Maximum relative humidity	No condensation
Life time (90 % survival rate)	100 000 h, at $t_c = 65$ °C 90 000 h, at $t_c = 70$ °C 60 000 h, at $t_c = 75$ °C

*) For other than independent use, higher t_s of the controlgear possible as long as highest allowed t_c point temperature is not exceeded

Quantity of drivers per miniature circuit breaker 16 A Type C

Based on inrush current I_{peak}	Typ. peak inrush current I_{peak}	1/2 value time, Δt	Calculated energy, $I_{peak}^2 \Delta t$
56 pcs	25 A	177 μ s	0.08 A ² s

CONVERSION TABLE FOR OTHER TYPES OF MINIATURE CIRCUIT BREAKER

MCB type	Relative quantity of LED drivers
B 10 A	37 %
B 16 A	60 %
B 20 A	75 %
C 10 A	62 %
C 16 A	100 % (see table above)
C 20 A	125 %

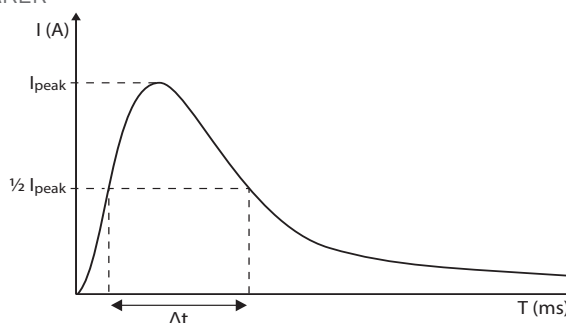

CONTINUOUS CURRENT

Total continuous current of the drivers and installation environment must always be considered and taken into calculations when installing drivers behind miniature circuit breaker. Example calculation of total drivers amount limited by continuous current: $n(I_{cont}) = [16 A (I_{nom, Ta}) / \text{"nominal mains current with full load"}] \times 0.76$. This calculation is an example according to recommended precautions due to multiple adjacent circuit breakers (> 9 MCBs) and installation environment (T_a 30 degrees); variables may vary according to the use case. Both inrush current and continuous current calculations are based on ABB S200 series circuit breakers. More specific information in ABB series S200 circuit breaker documentation.

NOTE! Type C MCB's are strongly recommended to use with LED lighting. Please see more details in "MCB information" document in each driver product page in "downloads & links" section.

Enhanced Hybrid dimming technique

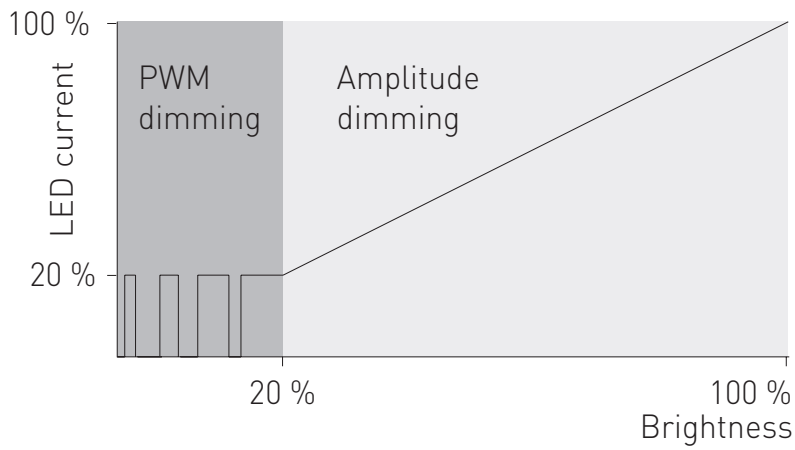

Dimming range	Dimming technique
1 % - 20 %	Pulse Width Modulation (PWM)*
20 % - 100 %	Amplitude (DC)

* PWM dimming frequency 1 kHz

Helvar hybrid dimming products combine the best features from Amplitude dimming and from Pulse Width Modulation (PWM) dimming. CCR is a very efficient technique for dimming the light output especially on higher range. On lower range, the hybrid dimming products implement high-frequency PWM dimming to ensure high quality dimming from 20 % down to 1 % providing low flicker dimming performance.

Freedom power output as external “luminaire intelligence unit” supply

Helvar Freedom drivers supports external control unit usage with the Freedom Node - power output. The driver can use the Freedom Node - output terminal to supply power and connect with Freedom Node - intelligent communication units via UART digital communication. The power supply specification and pin order for connector are listed in the details below. For further SW side integration, please contact Helvar.

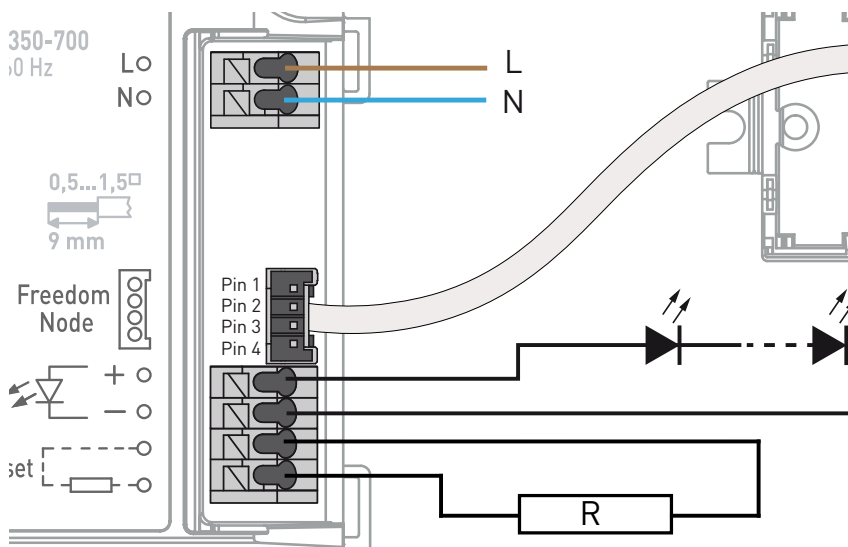

Pin connections

- Pin 1 Rx (Digital signal)*
- Pin 2 Ground
- Pin 3 VDD
- Pin 4 Tx (Digital signal)*

* Rx/Tx From LED driver perspective.

Power supply specification

- Voltage 3.3 V [±0.3V]*
- Continuous current max. 16 mA
- Peak current 30 mA (max. 100 ms each 5 Hz cycle)
- Standby mode current max. 10 mA**
- Connector MOLEX (35363-0460)

* Not continuous voltage supply by default.

** (Networked) standby power < 0,5 W

The UART communication follows Helvar Freedom Interface 1.5 by default. For more details about the communication protocol, please contact Helvar.

Connections and Mechanical Data

Wire size	0.5 mm ² – 1.5 mm ²
Wire type	Solid core and fine-stranded
Wire insulation	According to EN 60598
Maximum driver to LED wire length	1.5 m
Weight	190 g
IP rating	IP20

Connections



Note:

- Label may differ if the unit is preset to fixed current
- Not suitable for load side switching operation

Dimensions (mm)

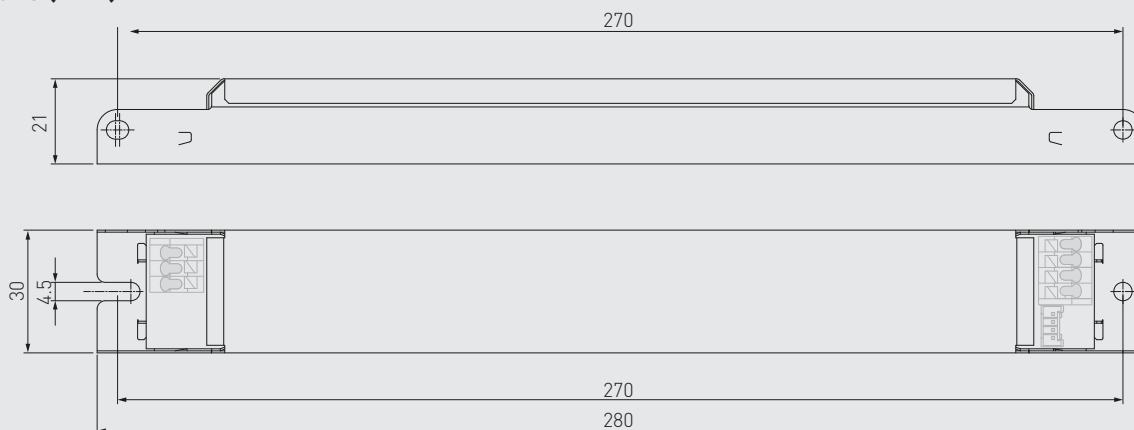

Output current can be set with the current setting resistor connected to the Iset terminal. Example current and resistor values across the range can be found in the following table. More information about the current setting resistor is given on page 5.

Iset current setting resistor values

R(Ω)	0	47	120	180	270	330	470	560	680	820	1k	1,2k	1,5k	1,8k	2,2k	2,74k	3,3k	3,9k	4,7k	5,6k	8,2k	12k	22k	∞
I _{out} (mA)	350	340	330	320	310	300	290	280	270	260	250	240	230	220	210	200	190	180	170	160	150	140	130	120
Order Code	T70000	T70470	N/A	N/A	T70271	T70331	T70471	N/A	T70681	T70821	T70102	N/A	T70152	N/A	T70222	T72741	T70332	T70392	T70472	T70562	T70822	T70123	N/A	N/A

LL10-42-FD-120-350 LED driver is suited for built-in usage in luminaires. With LL1x2130-SR strain reliefs, independent use is possible too (see the LL1x2130-SR datasheet for details). In order to have safe and reliable LED driver operation, the LED luminaires will need to comply with the relevant standards and regulations (e.g. IEC/EN 60598-1). The LED luminaire shall be designed to adequately protect the LED driver from dust, moisture and pollution. The luminaire manufacturer is responsible for the correct choice and installation of the LED drivers according to the application and product datasheets. Operating conditions of the LED drivers may never exceed the specifications as per the product datasheet.

Installation & operation

Maximum ambient and t_c temperature

- For built-in components inside luminaires, the t_a ambient temperature range is a guideline given for the optimum operating environment. However, integrator must always ensure proper thermal management (i.e. mounting base of the driver, air flow etc.) so that the t_c point temperature does not exceed the t_c maximum limit in any circumstance.
- Reliable operation and lifetime is only guaranteed if the maximum t_c point temperature is not exceeded under the conditions of use.

Current setting resistor

LL10-42-FD-120-350 LED driver features a constant current output adjustable via current setting resistor.

- An external resistor can be inserted in to the current setting terminal, allowing the user to adjust the LED driver output current
- When no external resistor is connected, then the LED drivers will operate at their default lowest current level
- A standard through-hole resistor can be used for the current setting. To achieve the most accurate output current it is recommended to select a quality low tolerance resistor. Minimum diameter for resistor leg is 0.51mm.
- Always connect the current setting resistor only into the terminals marked with I_{set} on the LED driver label.
- For the resistor/current value selection, refer to the table on page 4.

Miniature Circuit Breakers (MCB)

- Type-C MCB's with trip characteristics in according to EN 60898 are recommended.
- Please see more details in "MCB information" document in each driver product page in "downloads & links" section.

Lamp failure functionality

No load: When open load is detected, driver will go to standby. Automatic recovery is on during the first 10 minutes. If open load is still detected after the first 10 minutes, driver goes to standby mode and recovers through mains reset.

Overload: The driver can withstand overload. When small overvoltage occurs, the driver adaptively lower the output current to adjust the output power. When high overload occurs, the driver goes to standby.

Underload: The driver can withstand underload. When underload occurs, the driver goes to standby.

Short circuit: The driver can withstand output short circuit. When short circuit occurs, the driver goes to standby.

Conformity & standards

General and safety requirements	EN 61347-1: 2015
Particular safety requirements for DC or AC supplied electronic control gear for LED modules	EN 61347-2-13: 2014+ A1:2017
Thermal protection class	EN 61347, C5e
Mains current harmonics	EN 61000-3-2: 2014
Limits for voltage fluctuations and flicker	EN 61000-3-3: 2013
Radio frequency interference	EN 55015: 2013+ A1: 2015
Immunity standard	EN 61547: 2009
Performance requirements	EN 62384: 2006+ A1:2009
Compliant with relevant EU directives	
RoHS / REACH compliant	
CE marked	

Label symbols



Thermally controlled control gear, incorporating means of protection against overheating to prevent the case temperature under any conditions of use from exceeding 120 °C.



A control gear supporting a wireless luminaire control solutions via Freedom Interface.